

Every Day Use - Scanner Bin™

use Scanner Bin as a regular deskside bin, toss in receipts, notes, letters, product warranties, invoices, or anything else you want to scan

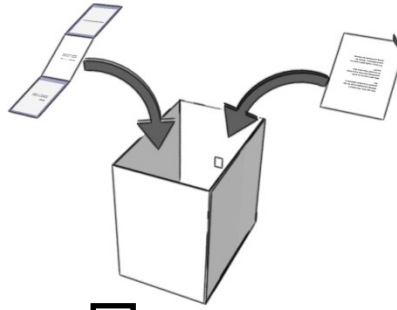

ScannerBin.com

Patent Pending

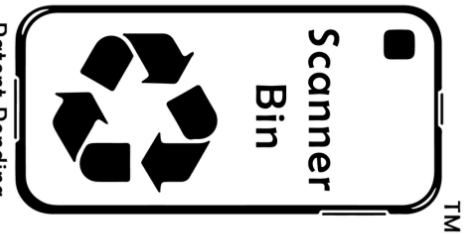

to scan documents, empty the contents of the bin and then place on desk with cutout facing up

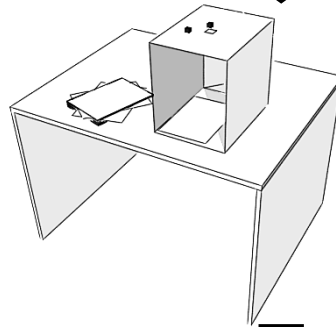

Thank you for purchasing Scanner Bin!

Get the most out of our product, visit ScannerBin.com to learn methods, tips and tricks.

position smartphone using alignment bumpers



Questions:
help@scannerbin.com

use the transparent Flat Sheet to hold folded paper flat, Flat Sheet cut-out is positioned directly below smartphone to avoid glare



Free 3rd Party Scanner Apps:

- CamScanner
- Genius Scan
- TinyScan
- Evernote Scannable
- Smart Doc Scanner
- Fast Scanner
- Quick PDF Scanner
- MDScan

and many more..

utilize a scanning application or the standard camera app to scan images



[Set-up Instructions →](#)

For instructional videos, visit:
www.ScannerBin.com/setup-and-use

Patent Pending
Made in USA

Set-up - Scanner Bin™

1st

remove clip,
paperwork, and
check packing list

open box, straighten
flaps

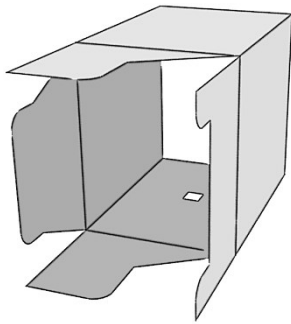

2nd

use your smartphone
to download a
scanning application,
there are several free
options – search
“document scanner”



fold first flap as
shown in this picture

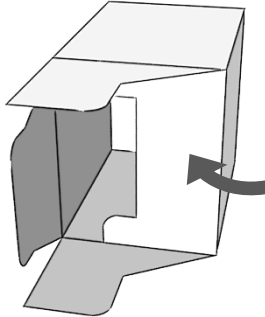

place smartphone
onto Scanner Bin
with camera/flash
pointing through
cutout

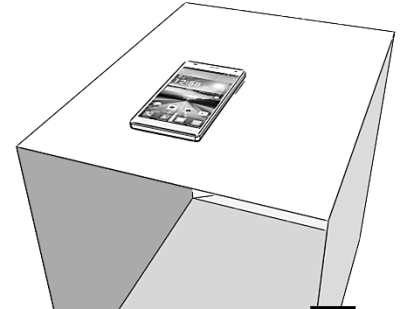

fold second flap as
shown in this picture

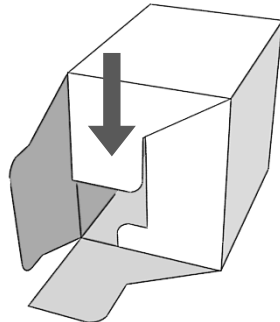

place test page
aligned to right edge
and take test
images.

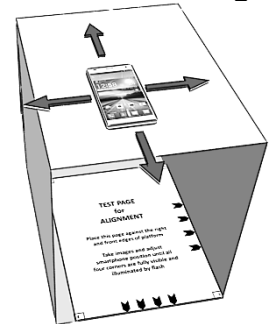

adjust smartphone
position as needed.

fold third flap as
shown in this picture

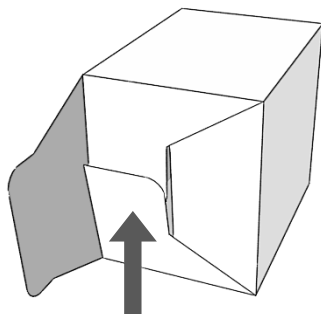

hold phone in place
and use pencil to
trace two 1/2” lines
along top and
bottom edges of
smartphone at the
center of each edge

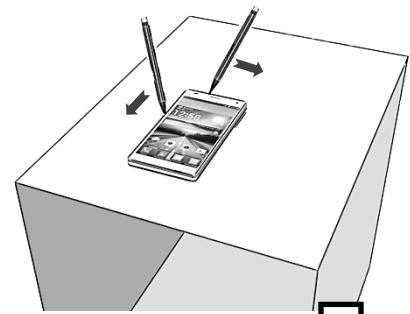

fold final flap and
push into the box to
snap into place

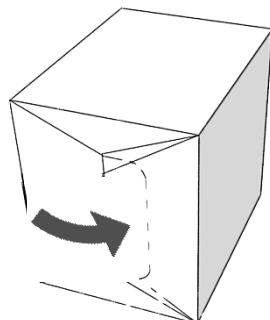

remove smartphone
and place two
adhesive bumpers
with edges aligned to
trace marks

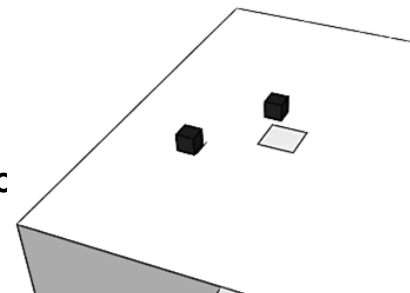

For instructional videos, visit:
www.ScannerBin.com/setup-and-use

Use Instructions →

TEST PAGE for ALIGNMENT



**Place this page against the right
and front edges of platform**



**Take images and adjust
smartphone position until all
four corners are fully visible and
illuminated by flash**



Packing List

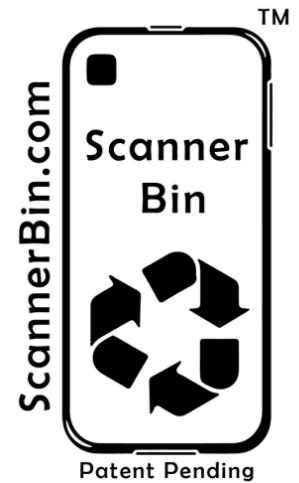

One Scanner Bin

One binder clip

Two Alignment Bumpers (placed inside Scanner Bin cutout for shipping)

One double-sided Instructions sheet

One transparent Flat Sheet

One Test Page for Alignment (back of this sheet)